

Figure 8.1 Tile Dimensions

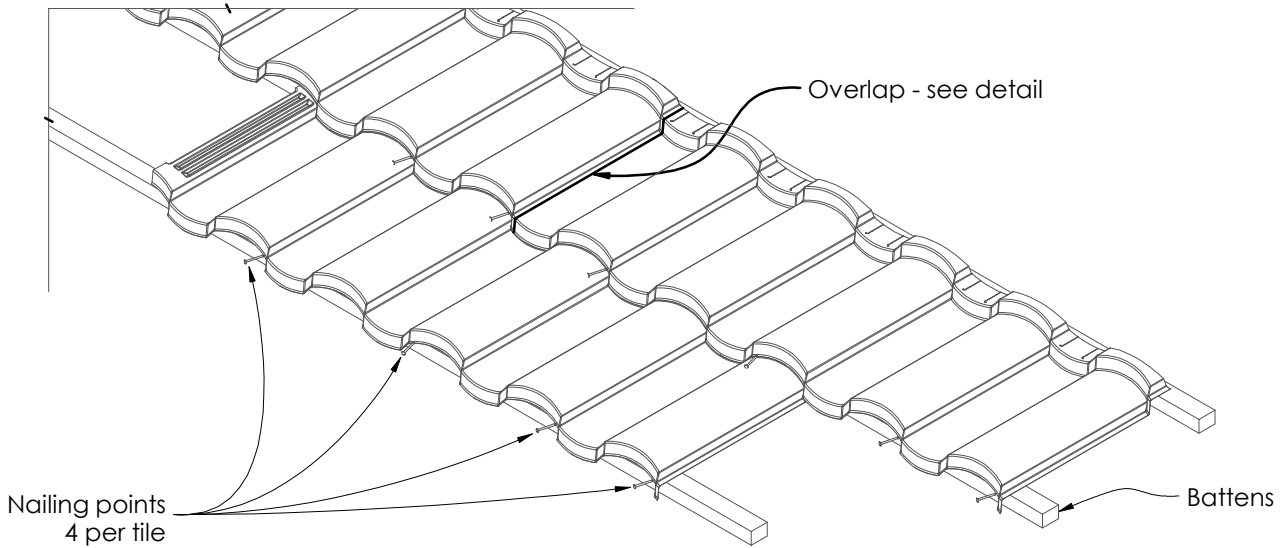

Figure 8.2 Nailing Detail

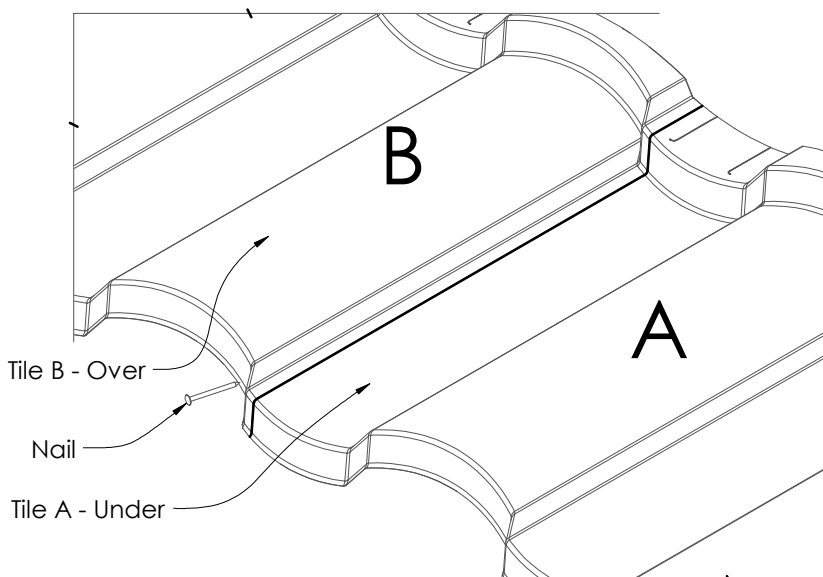

Figure 8.3 Overlap Detail

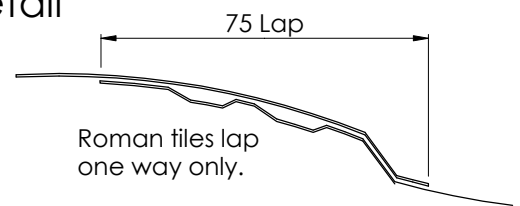

Figure 8.4 Lap Section

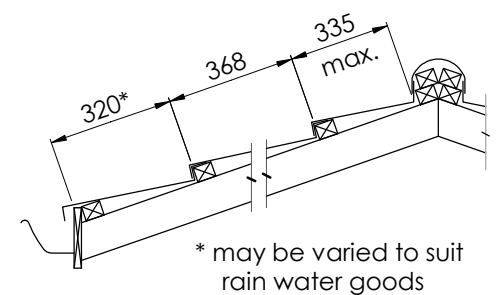

Figure 8.5 Batten Layout