

Figure 2.1 Tile Dimensions

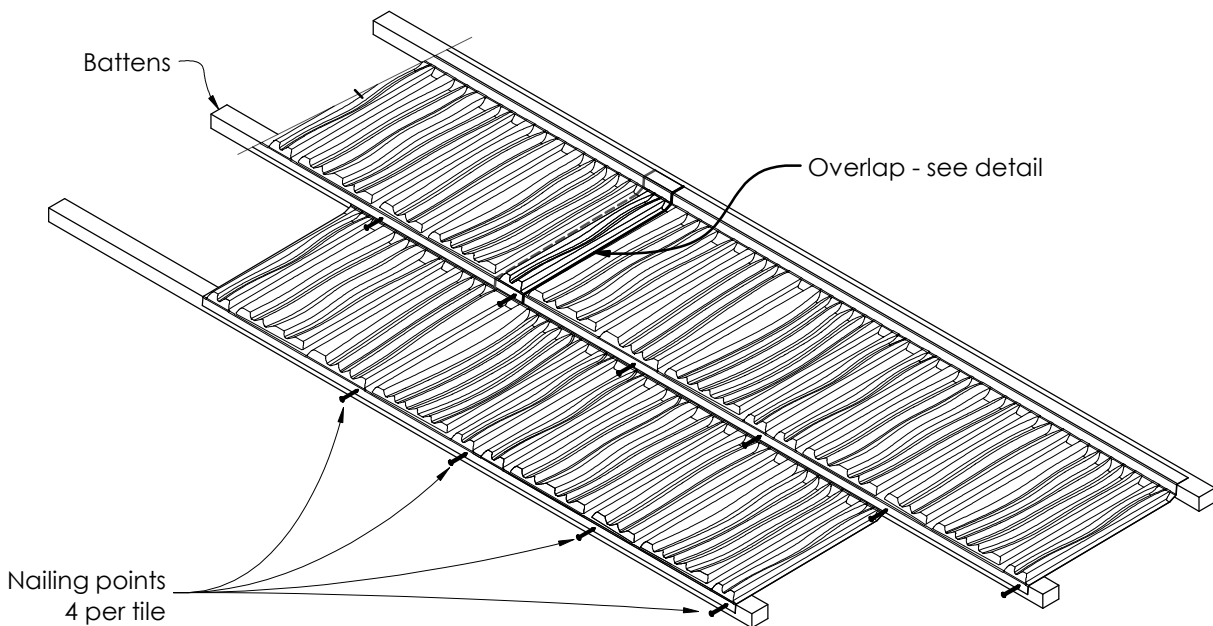

Figure 2.2 Nailing Detail

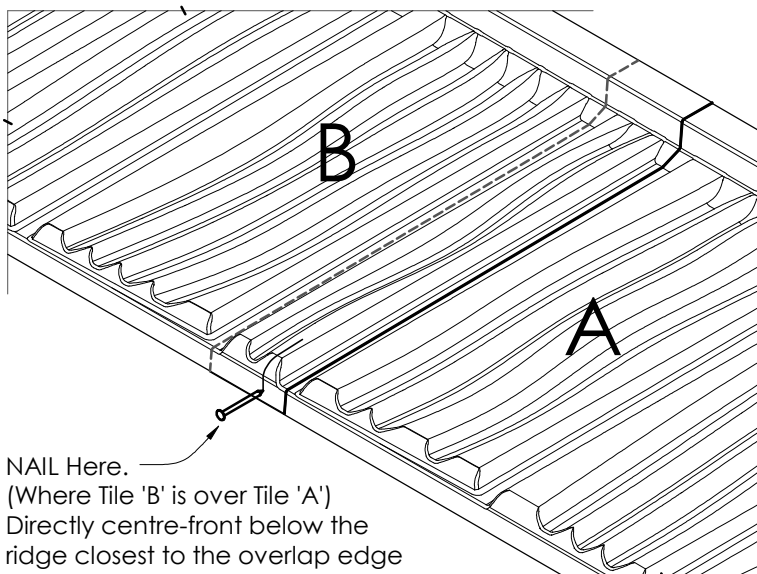

Figure 2.3 Overlap Detail

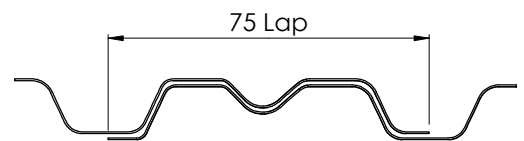

Figure 2.4 Lap Section

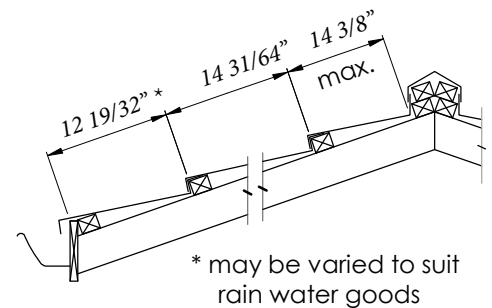

Figure 2.5 Batten Layout